

SKT 551



Capsule Thyristors

Thyristors

SKT 551

Features

- Hermetic metal case with ceramic insulator
- Capsule package for double sided cooling
- Shallow design with single sided cooling
- International standard case
- Off-state and reverse voltages up to 1800 V
- Amplifying gate

Typical Applications*

- DC motor control (e. g. for machine tools)
- Controlled rectifiers (e. g. for battery charging)
- AC controllers (e. g. for temperature control)
- Recommended snubber network e.g. for $V_{VRMS} \leq 400$ V:
 $R = 33 \Omega / 32$ W, $C = 0,47 \mu F$

V_{RSM} V	V_{RRM}, V_{DRM} V	$I_{TRMS} = 1200$ A (maximum value for continuous operation) $I_{TAV} = 550$ A (sin. 180; DSC; $T_c = 85$ °C)	
1300	1200	SKT 551/12E	
1700	1600	SKT 551/16E	
1900	1800	SKT 551/18E	

Symbol	Conditions	Values	Units
I_{TAV}	sin. 180; $T_c = 100$ (85) °C;	391 (550)	A
I_D	2 x P8/180; $T_a = 45$ °C; B2 / B6	390 / 560	A
	2 x P8/180 F; $T_a = 35$ °C; B2 / B6	980 / 1340	A
I_{RMS}	2 x P8/180; $T_a = 45$ °C; W1C	430	A
I_{TSM}	$T_{vj} = 25$ °C; 10 ms	9000	A
	$T_{vj} = 125$ °C; 10 ms	8000	A
i^2t	$T_{vj} = 25$ °C; 8,3 ... 10 ms	405000	A ² s
	$T_{vj} = 125$ °C; 8,3 ... 10 ms	320000	A ² s
V_T	$T_{vj} = 25$ °C; $I_T = 1500$ A	max. 1,65	V
$V_{T(TO)}$	$T_{vj} = 125$ °C	max. 0,925	V
r_T	$T_{vj} = 125$ °C	max. 0,45	mΩ
I_{DD}, I_{RD}	$T_{vj} = 125$ °C; $V_{RD} = V_{RRM}; V_{DD} = V_{DRM}$	max. 60	mA
t_{gd}	$T_{vj} = 25$ °C; $I_G = 1$ A; $di_G/dt = 1$ A/μs	1	μs
t_{gr}	$V_D = 0,67 * V_{DRM}$	1	μs
$(di/dt)_{cr}$	$T_{vj} = 125$ °C	max. 125	A/μs
$(dv/dt)_{cr}$	$T_{vj} = 125$ °C	max. 1000	V/μs
t_q	$T_{vj} = 125$ °C	50 ... 150	μs
I_H	$T_{vj} = 25$ °C; typ. / max.	150 / 500	mA
I_L	$T_{vj} = 25$ °C; $R_G = 33 \Omega$; typ. / max.	500 / 2000	mA
V_{GT}	$T_{vj} = 25$ °C; d.c.	min. 3	V
I_{GT}	$T_{vj} = 25$ °C; d.c.	min. 250	mA
V_{GD}	$T_{vj} = 125$ °C; d.c.	max. 0,25	V
I_{GD}	$T_{vj} = 125$ °C; d.c.	max. 10	mA
$R_{th(j-c)}$	cont.; DSC	0,045	K/W
	sin. 180; DSC / SSC	0,047 / 0,1	K/W
	rec. 120; DSC / SSC	0,054 / 0,113	K/W
$R_{th(c-s)}$	DSC / SSC	0,012 / 0,024	K/W
T_{vj}		- 40 ... + 125	°C
T_{stg}		- 40 ... + 130	°C
V_{isol}		-	V~
F	mounting force	5,2 ... 8	kN
a			m/s ²
m	approx.	105	g
Case		B 11	

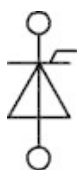

SKT

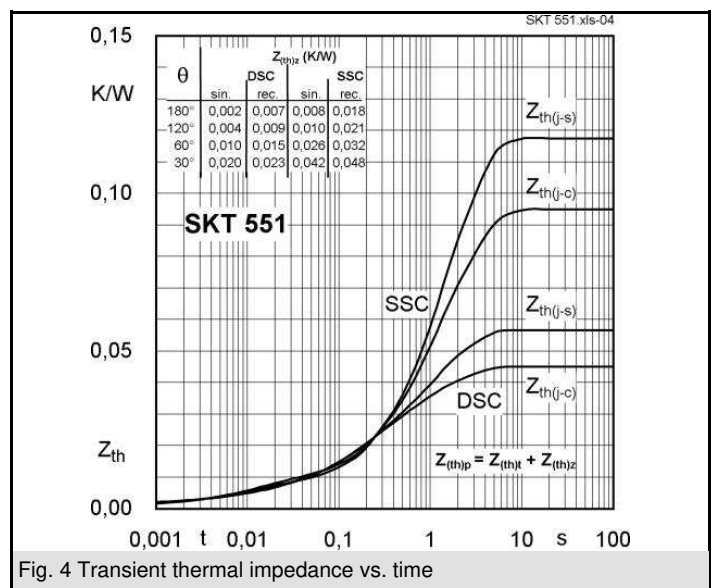
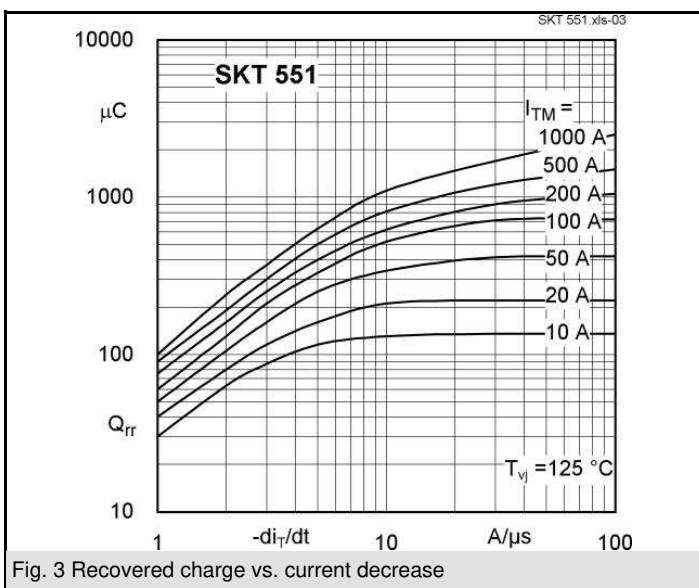
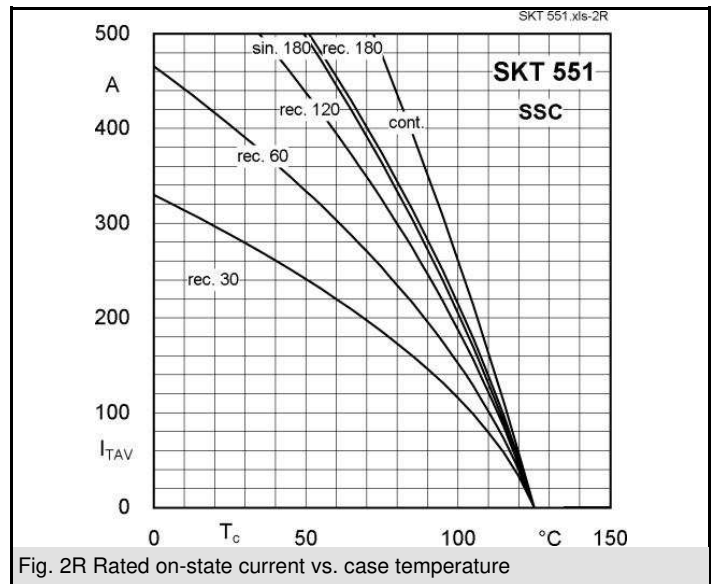
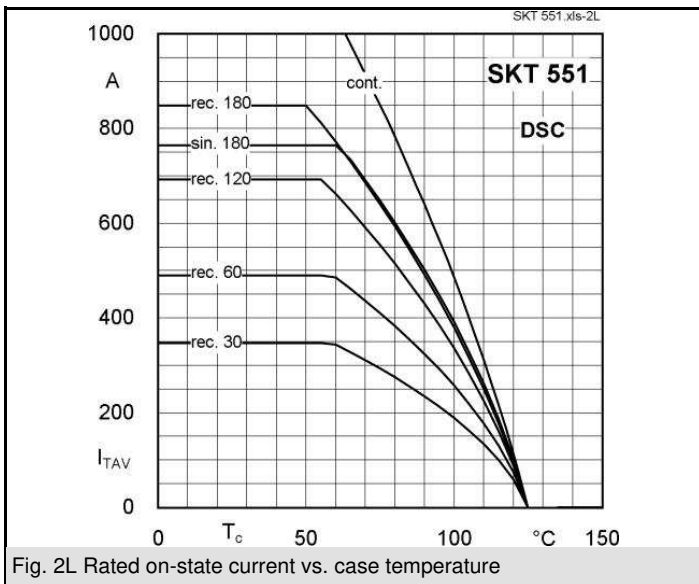
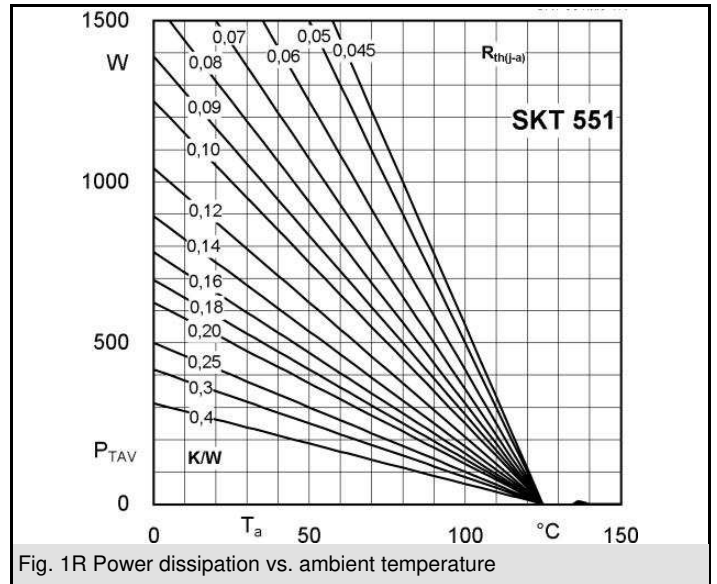
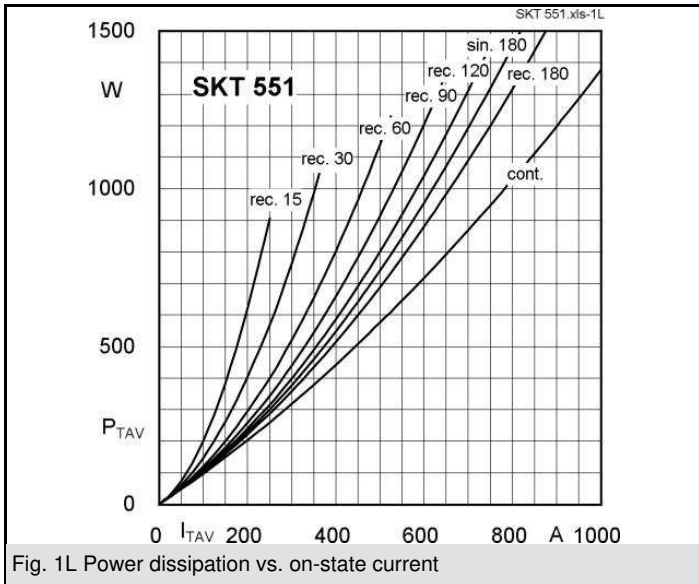

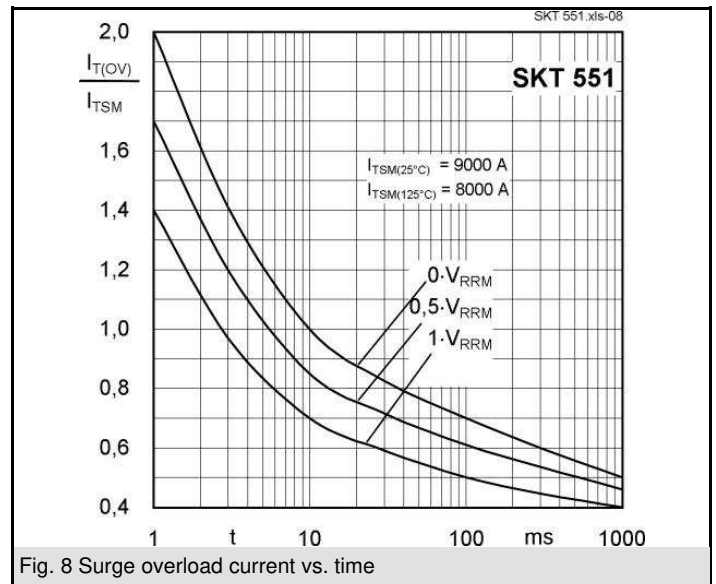
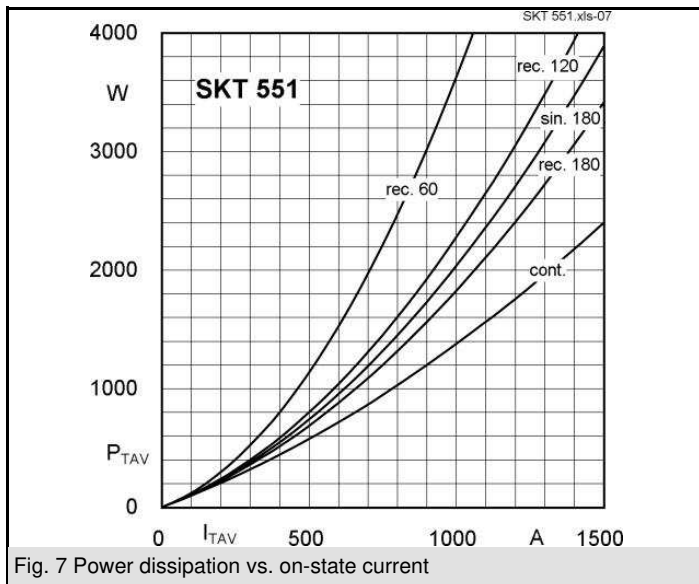
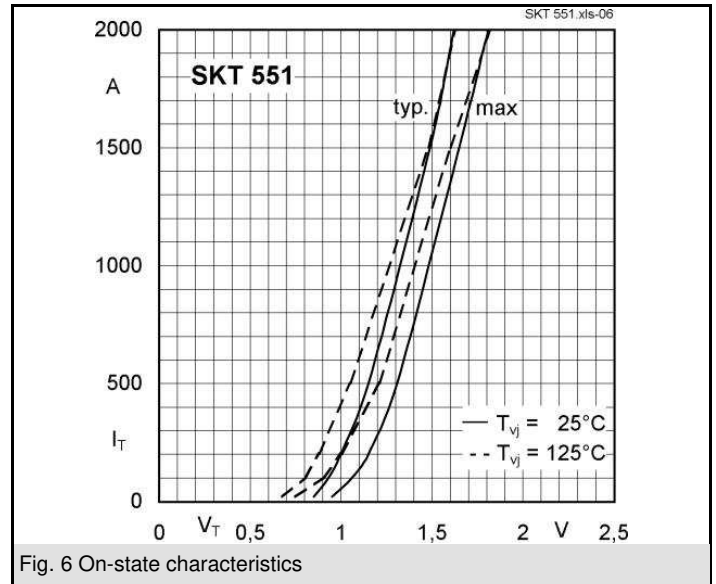
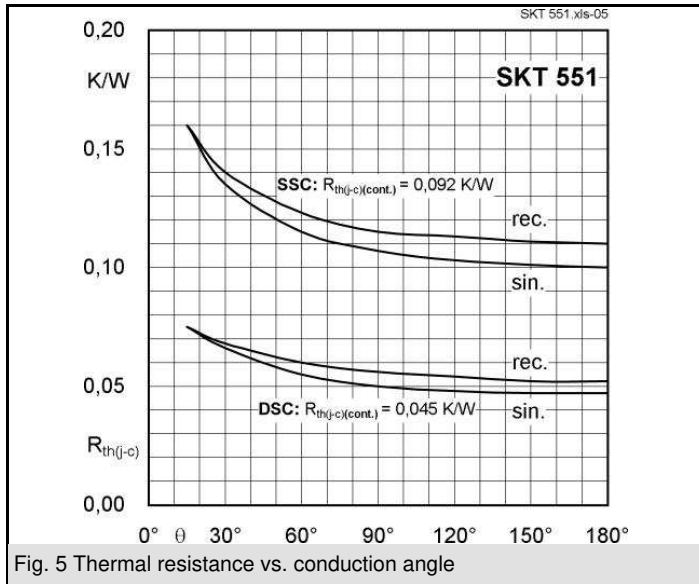

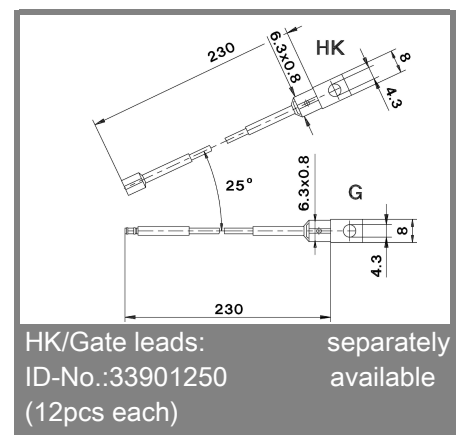
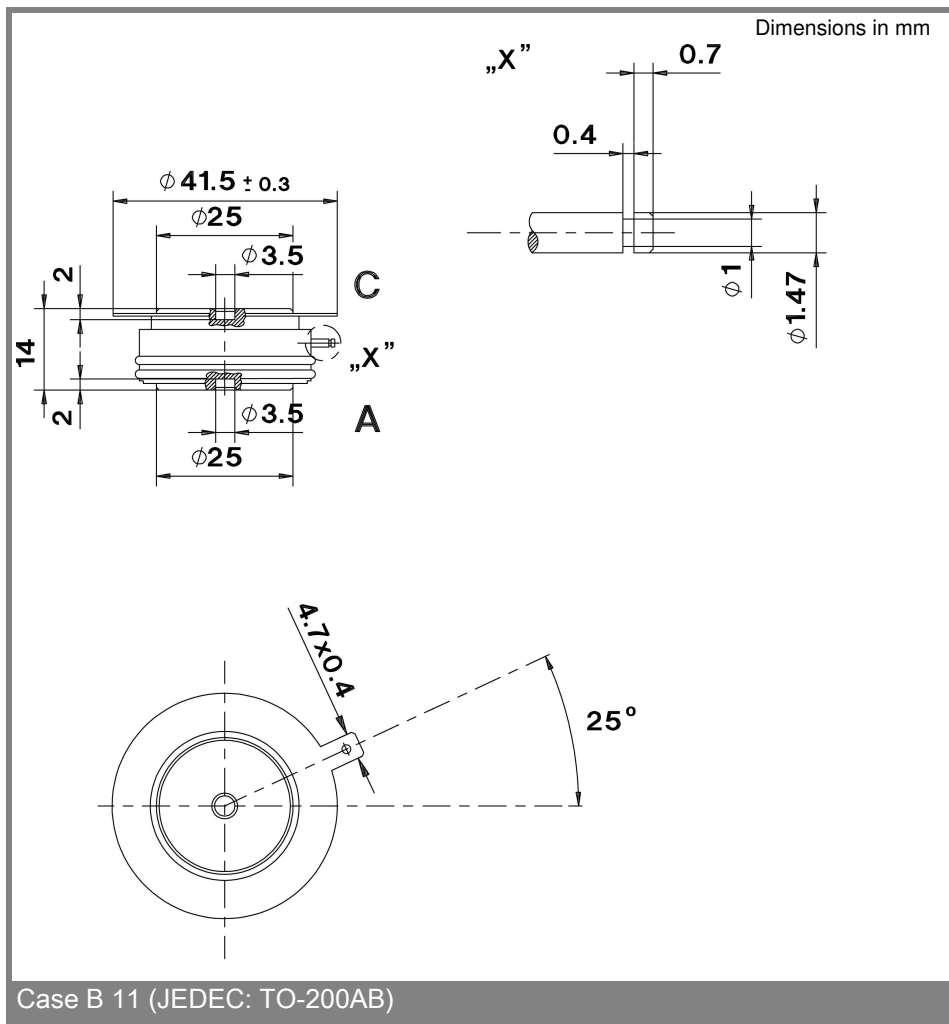
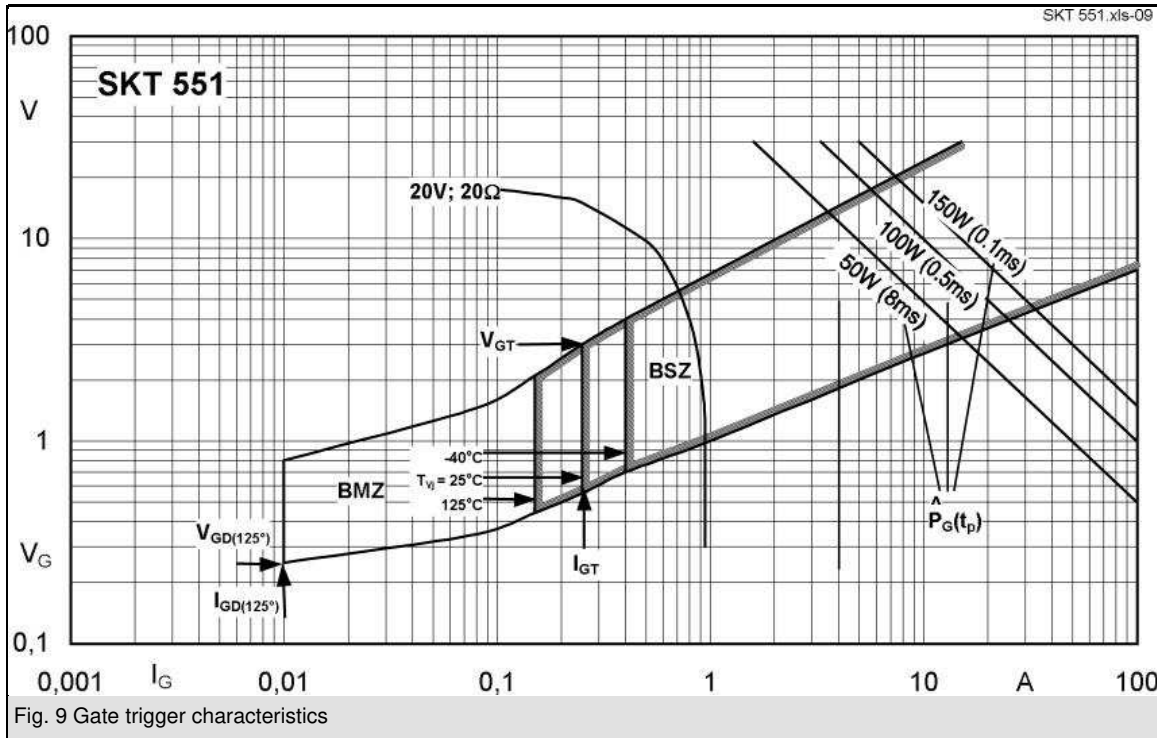

* The specifications of our components may not be considered as an assurance of component characteristics. Components have to be tested for the respective application. Adjustments may be necessary. The use of SEMIKRON

products in life support appliances and systems is subject to prior specification and written approval by SEMIKRON. We therefore strongly recommend prior consultation of our staff.