

# SKKT 72, SKKH 72, SKKT 72B



## SEMIPACK<sup>®</sup> 1

### Thyristor / Diode Modules

**SKKT 72**  
**SKKH 72**  
**SKKT 72B**

#### Features

- Heat transfer through aluminium oxide ceramic isolated metal baseplate
- Hard soldered joints for high reliability
- UL recognized, file no. E 63 532

#### Typical Applications\*

- DC motor control (e. g. for machine tools)
- AC motor soft starters
- Temperature control (e. g. for ovens, chemical processes)
- Professional light dimming (studios, theaters)

1) See the assembly instructions

$V_{RSM}$ V	$V_{RRM}, V_{DRM}$ V	$I_{TRMS} = 125$ A (maximum value for continuous operation)		
		$I_{TAV} = 70$ A (sin. 180; $T_c = 85$ °C)		
900	800	SKKT 72/08E	SKKT 72B08E	SKKH 72/08E
1300	1200	SKKT 72/12E	SKKT 72B12E	SKKH 72/12E
1500	1400	SKKT 72/14E	SKKT 72B14E	SKKH 72/14E
1700	1600	SKKT 72/16E	SKKT 72B16E	SKKH 72/16E
1900	1800	SKKT 72/18E	SKKT 72B18E	SKKH 72/18E

Symbol	Conditions	Values	Units
$I_{TAV}$	sin. 180; $T_c = 85$ (100) °C;	70 (50)	A
$I_D$	P3/180; $T_a = 45$ °C; B2 / B6	62 / 75	A
	P3/180F; $T_a = 35$ °C; B2 / B6	115 / 145	A
$I_{RMS}$	P3/180F; $T_a = 35$ °C; W1 / W3	155 / 3 * 115	A
$I_{TSM}$	$T_{vj} = 25$ °C; 10 ms	1600	A
	$T_{vj} = 125$ °C; 10 ms	1450	A
$i^2t$	$T_{vj} = 25$ °C; 8,3 ... 10 ms	13000	A <sup>2</sup> s
	$T_{vj} = 125$ °C; 8,3 ... 10 ms	10500	A <sup>2</sup> s
$V_T$	$T_{vj} = 25$ °C; $I_T = 300$ A	max. 1,9	V
$V_{T(TO)}$	$T_{vj} = 125$ °C	max. 0,9	V
$r_T$	$T_{vj} = 125$ °C	max. 3,5	mΩ
$I_{DD}, I_{RD}$	$T_{vj} = 125$ °C; $V_{RD} = V_{RRM}, V_{DD} = V_{DRM}$	max. 20	mA
$t_{gd}$	$T_{vj} = 25$ °C; $I_G = 1$ A; $di_G/dt = 1$ A/μs	1	μs
$t_{gr}$	$V_D = 0,67 * V_{DRM}$	1	μs
$(di/dt)_{cr}$	$T_{vj} = 125$ °C	max. 150	A/μs
$(dv/dt)_{cr}$	$T_{vj} = 125$ °C	max. 1000	V/μs
$t_q$	$T_{vj} = 125$ °C,	80	μs
$I_H$	$T_{vj} = 25$ °C; typ. / max.	150 / 250	mA
$I_L$	$T_{vj} = 25$ °C; $R_G = 33$ Ω; typ. / max.	300 / 600	mA
$V_{GT}$	$T_{vj} = 25$ °C; d.c.	min. 3	V
$I_{GT}$	$T_{vj} = 25$ °C; d.c.	min. 150	mA
$V_{GD}$	$T_{vj} = 125$ °C; d.c.	max. 0,25	V
$I_{GD}$	$T_{vj} = 125$ °C; d.c.	max. 6	mA
$R_{th(j-c)}$	cont.; per thyristor / per module	0,35 / 0,18	K/W
$R_{th(j-c)}$	sin. 180; per thyristor / per module	0,37 / 0,19	K/W
$R_{th(j-c)}$	rec. 120; per thyristor / per module	0,39 / 0,2	K/W
$R_{th(c-s)}$	per thyristor / per module	0,2 / 0,1	K/W
$T_{vj}$		- 40 ... + 125	°C
$T_{stg}$		- 40 ... + 125	°C
$V_{isol}$	a. c. 50 Hz; r.m.s.; 1 s / 1 min.	3600 / 3000	V~
$M_s$	to heatsink	$5 \pm 15$ % <sup>1)</sup>	Nm
$M_t$	to terminals	$3 \pm 15$ %	Nm
$a$		$5 * 9,81$	m/s <sup>2</sup>
$m$	approx.	95	g
Case	SKKT	A 46	
	SKKT ...B	A 48	
	SKKH	A 47	



**SKKT**      **SKKH**

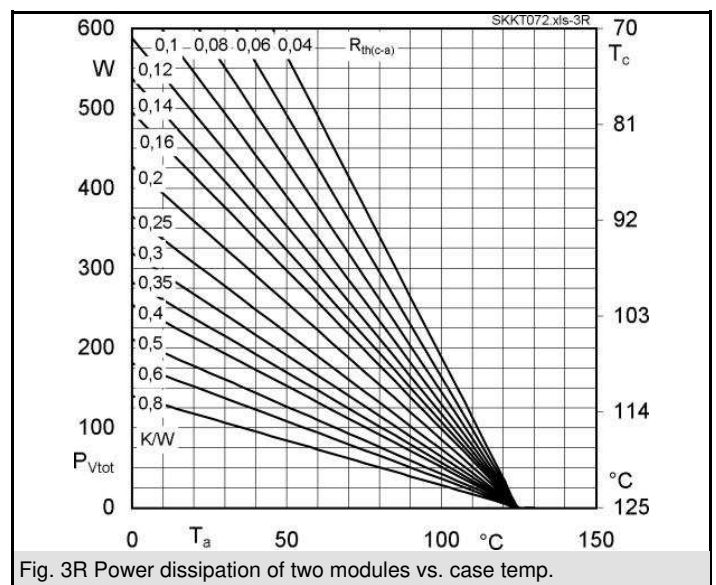
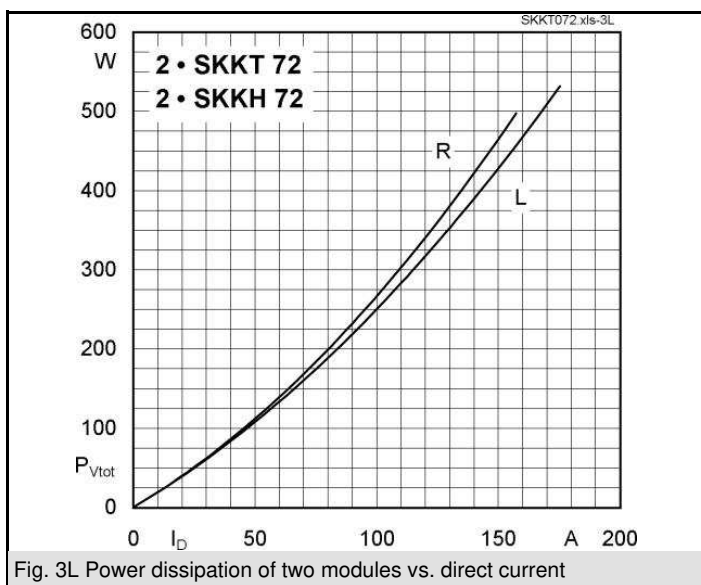
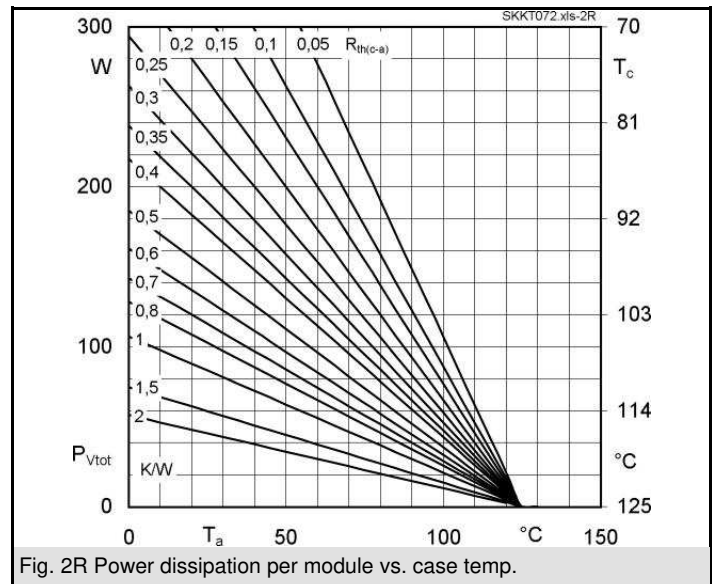
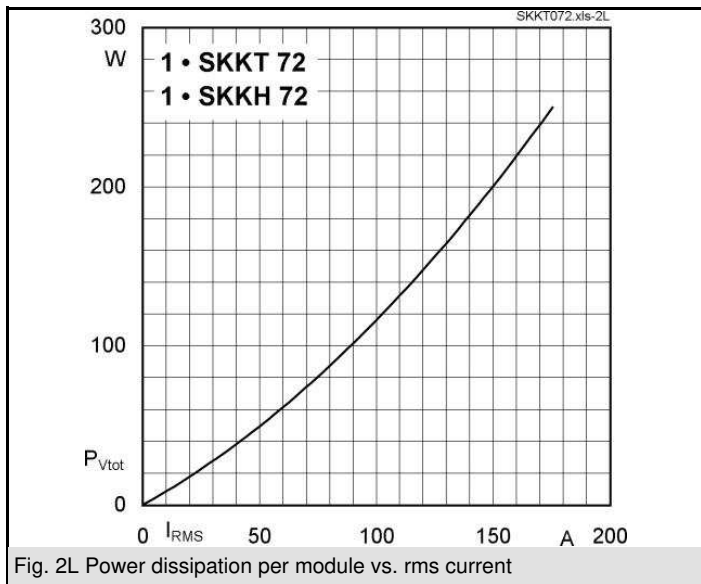
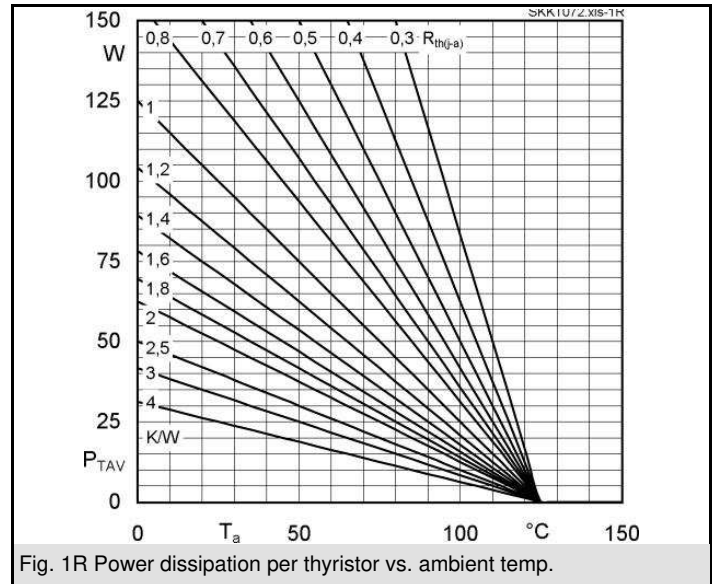
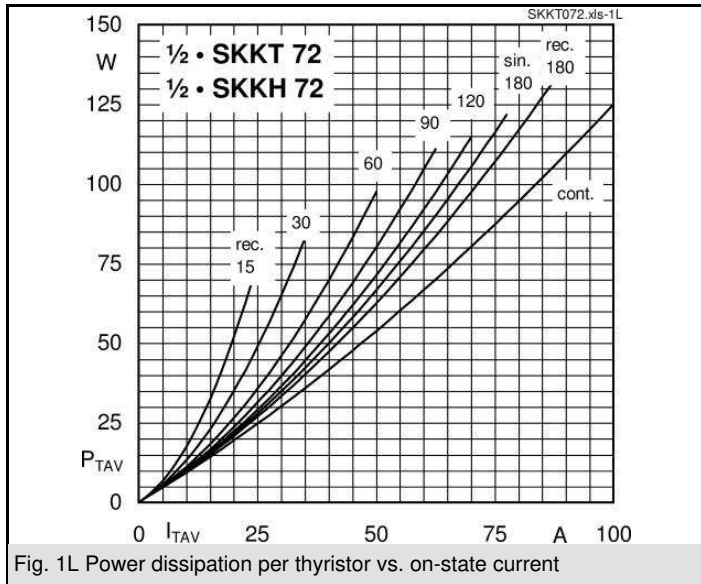

# SKKT 72, SKKH 72, SKKT 72B

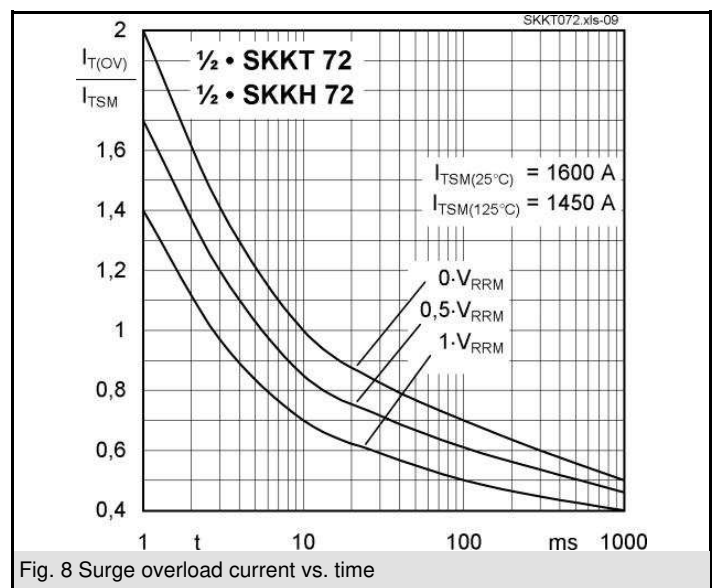
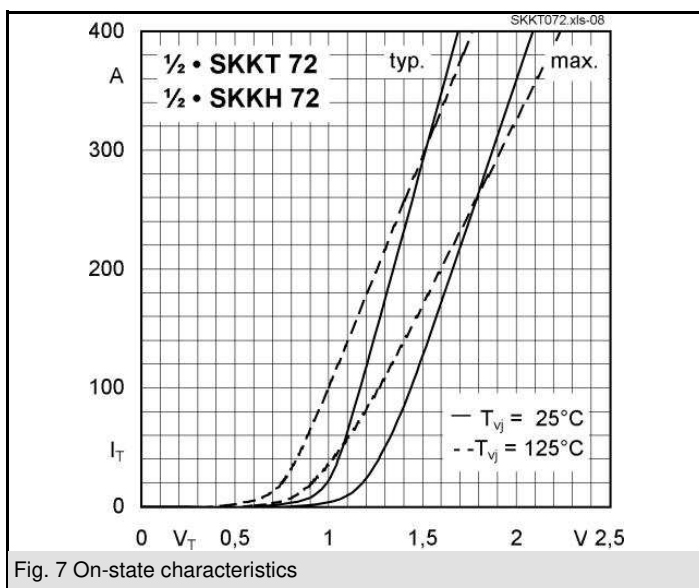
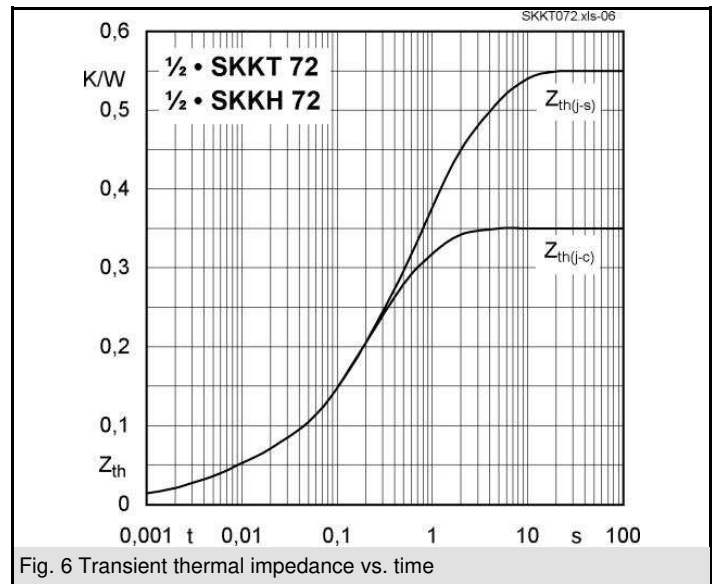
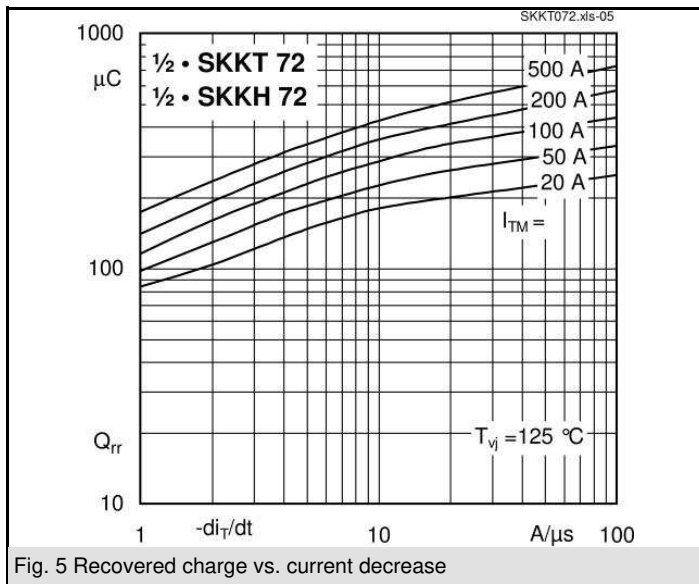
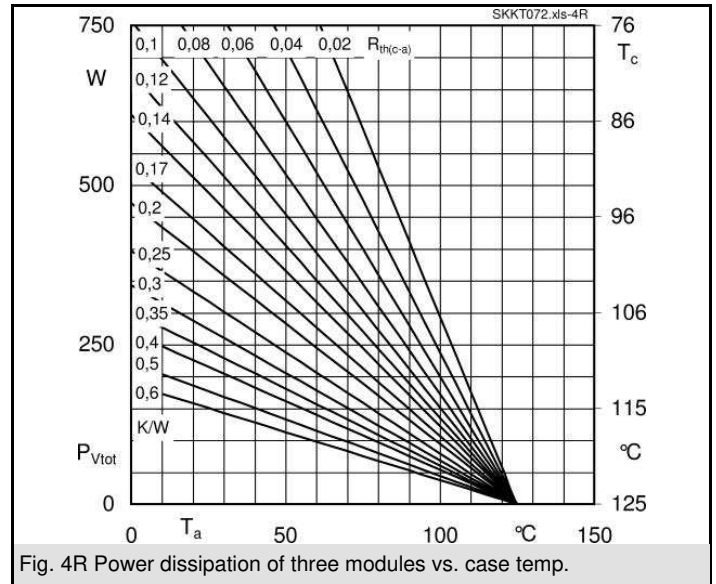
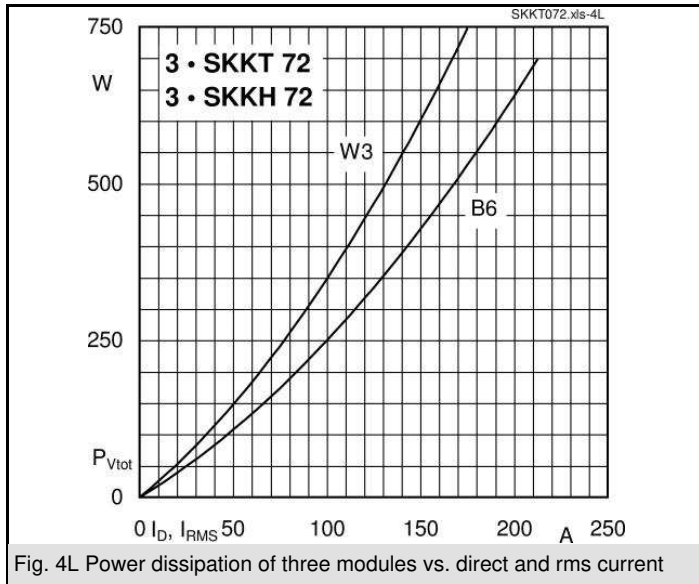

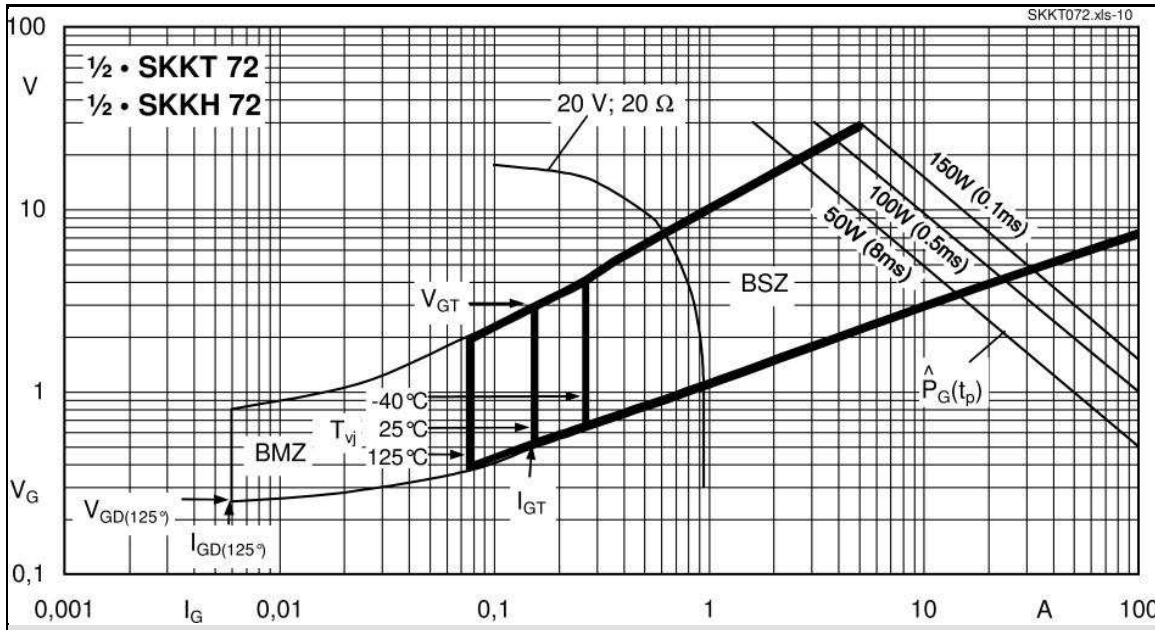
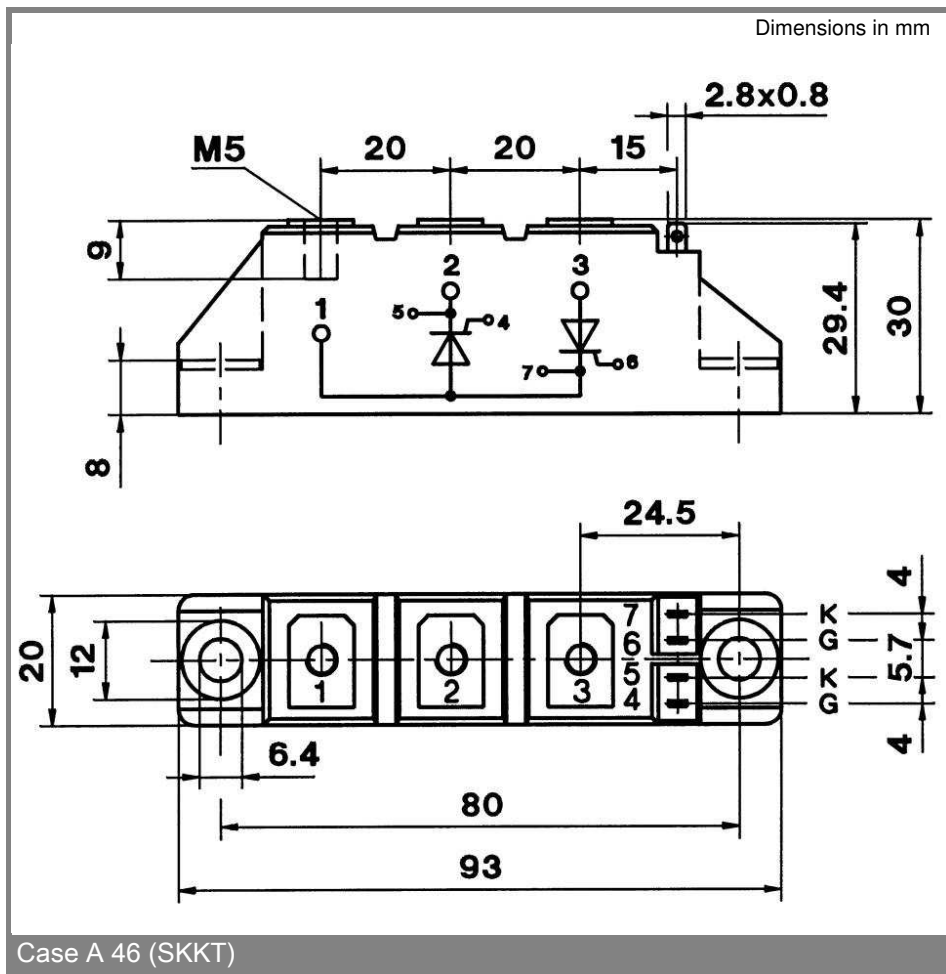
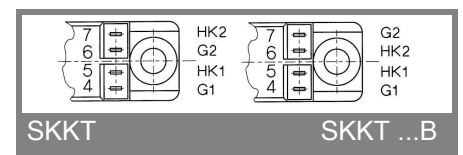
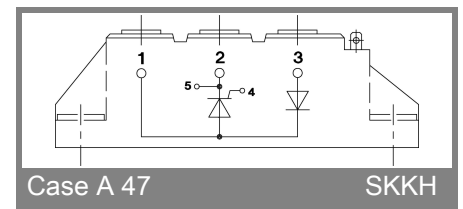
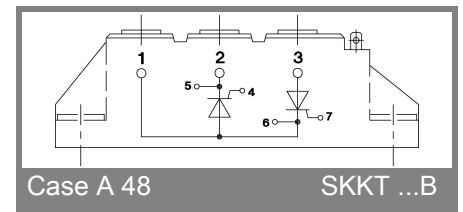

Fig. 9 Gate trigger characteristics



Case A 46 (SKKT)



\* The specifications of our components may not be considered as an assurance of component characteristics. Components have to be tested for the respective application. Adjustments may be necessary. The use of SEMIKRON products in life support appliances and systems is subject to prior specification and written approval by SEMIKRON. We therefore strongly recommend prior consultation of our personal.