

SKKT 42, SKKT 42B, SKKH 42



SEMIPACK® 1

Thyristor / Diode Modules

SKKT 42
SKKT 42B
SKKH 42

Features

- Heat transfer through aluminium oxide ceramic isolated metal baseplate
- Hard soldered joints for high reliability
- UL recognized, file no. E 63 532

Typical Applications*

- DC motor control (e. g. for machine tools)
- AC motor soft starters
- Temperature control (e. g. for ovens, chemical processes)
- Professional light dimming (studios, theaters)

1) See the assembly instructions

| V_{RSM} V | V_{RRM}, V_{DRM} V | $I_{TRMS} = 75$ A (maximum value for continuous operation) | | |
|----------------|-------------------------|--|-------------|-------------|
| | | $I_{TAV} = 40$ A (sin. 180; $T_c = 85$ °C) | | |
| 900 | 800 | SKKT 42/08E | SKKT 42B08E | SKKH 42/08E |
| 1300 | 1200 | SKKT 42/12E | SKKT 42B12E | SKKH 42/12E |
| 1500 | 1400 | SKKT 42/14E | SKKT 42B14E | SKKH 42/14E |
| 1700 | 1600 | SKKT 42/16E | SKKT 42B16E | SKKH 42/16E |
| 1900 | 1800 | SKKT 42/18E | SKKT 42B18E | SKKH 42/18E |

| Symbol | Conditions | Values | Units |
|------------------|---|------------------------|-------|
| I_{TAV} | sin. 180; $T_c = 85$ (100) °C; | 40 (28) | A |
| I_D | P3/180; $T_a = 45$ °C; B2 / B6 | 50 / 60 | A |
| | P3/180F; $T_a = 35$ °C; B2 / B6 | 85 / 110 | A |
| I_{RMS} | P3/180F; $T_a = 35$ °C; W1 / W3 | 110 / 3 * 85 | A |
| I_{TSM} | $T_{vj} = 25$ °C; 10 ms | 1000 | A |
| | $T_{vj} = 125$ °C; 10 ms | 850 | A |
| i^2t | $T_{vj} = 25$ °C; 8,3 ... 10 ms | 5000 | A²s |
| | $T_{vj} = 125$ °C; 8,3 ... 10 ms | 3600 | A²s |
| V_T | $T_{vj} = 25$ °C; $I_T = 200$ A | max. 1,95 | V |
| $V_{T(TO)}$ | $T_{vj} = 125$ °C | max. 1 | V |
| r_T | $T_{vj} = 125$ °C | max. 4,5 | mΩ |
| $I_{DD}; I_{RD}$ | $T_{vj} = 125$ °C; $V_{RD} = V_{RRM}; V_{DD} = V_{DRM}$ | max. 15 | mA |
| t_{gd} | $T_{vj} = 25$ °C; $I_G = 1$ A; $di_G/dt = 1$ A/μs | 1 | μs |
| t_{gr} | $V_D = 0,67 * V_{DRM}$ | 2 | μs |
| $(di/dt)_{cr}$ | $T_{vj} = 125$ °C | max. 150 | A/μs |
| $(dv/dt)_{cr}$ | $T_{vj} = 125$ °C | max. 1000 | V/μs |
| t_q | $T_{vj} = 125$ °C | 80 | μs |
| I_H | $T_{vj} = 25$ °C; typ. / max. | 150 / 250 | mA |
| I_L | $T_{vj} = 25$ °C; $R_G = 33$ Ω; typ. / max. | 300 / 600 | mA |
| V_{GT} | $T_{vj} = 25$ °C; d.c. | min. 3 | V |
| I_{GT} | $T_{vj} = 25$ °C; d.c. | min. 150 | mA |
| V_{GD} | $T_{vj} = 125$ °C; d.c. | max. 0,25 | V |
| I_{GD} | $T_{vj} = 125$ °C; d.c. | max. 6 | mA |
| $R_{th(j-c)}$ | cont.; per thyristor / per module | 0,65 / 0,33 | K/W |
| $R_{th(j-c)}$ | sin. 180; per thyristor / per module | 0,69 / 0,35 | K/W |
| $R_{th(j-c)}$ | rec. 120; per thyristor / per module | 0,73 / 0,37 | K/W |
| $R_{th(c-s)}$ | per thyristor / per module | 0,2 / 0,1 | K/W |
| T_{vj} | | - 40 ... + 125 | °C |
| T_{stg} | | - 40 ... + 125 | °C |
| V_{isol} | a. c. 50 Hz; r.m.s.; 1 s / 1 min. | 3600 / 3000 | V~ |
| M_s | to heatsink | 5 ± 15 % ¹⁾ | Nm |
| M_t | to terminals | 3 ± 15 % | Nm |
| a | | 5 * 9,81 | m/s² |
| m | approx. | 95 | g |
| Case | SKKT | A 46 | |
| | SKKT ...B | A 48 | |
| | SKKH | A 47 | |



SKKT SKKH

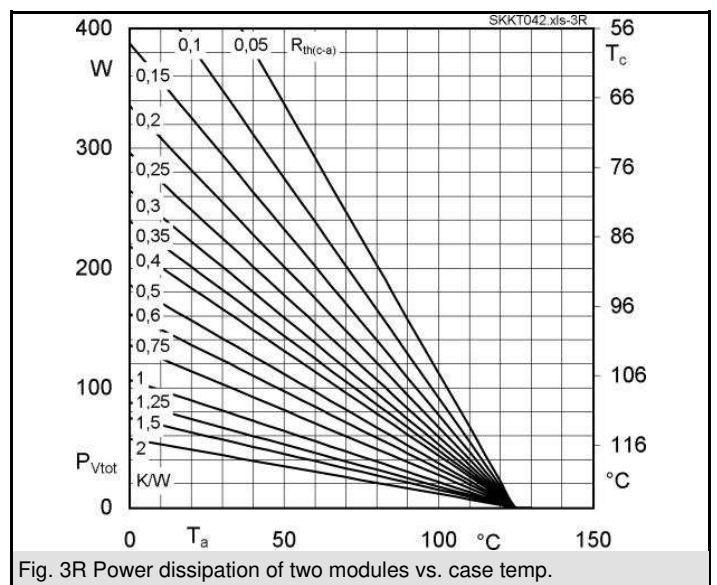
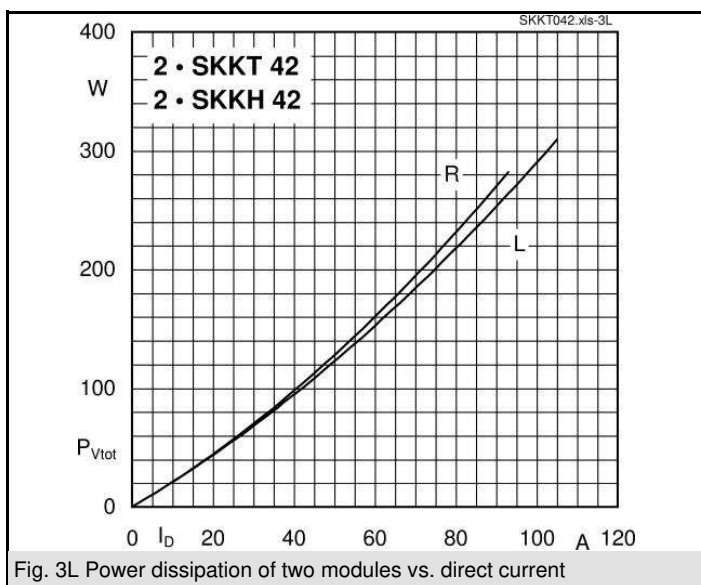
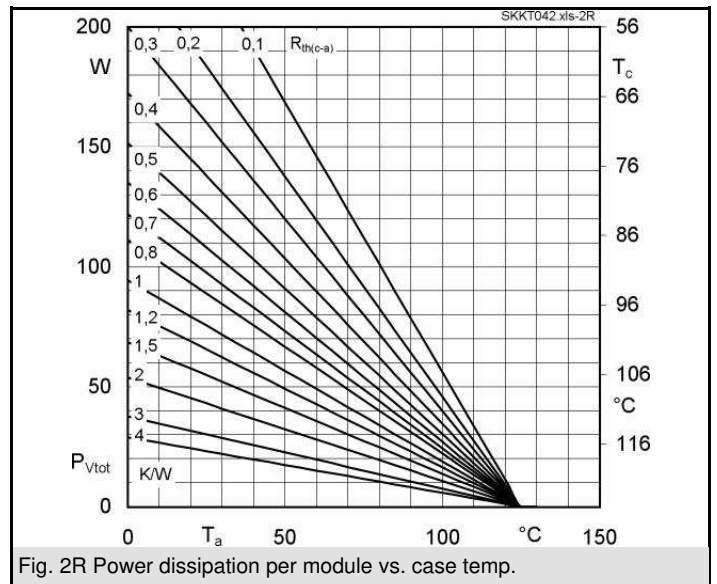
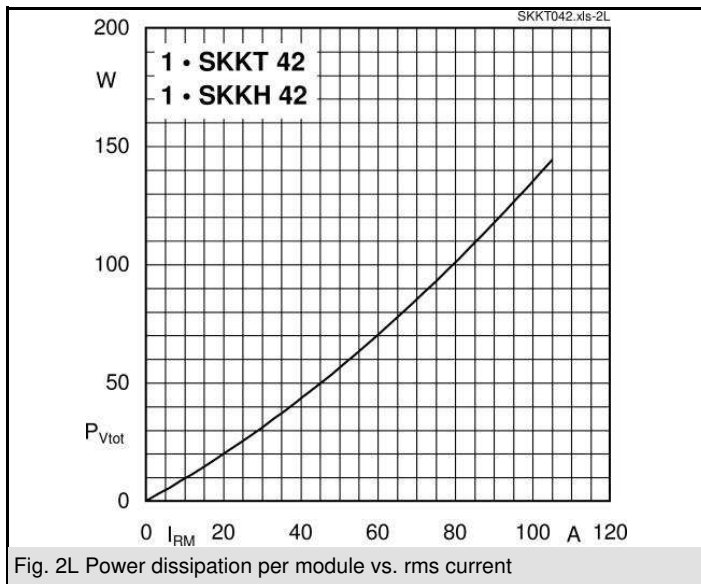
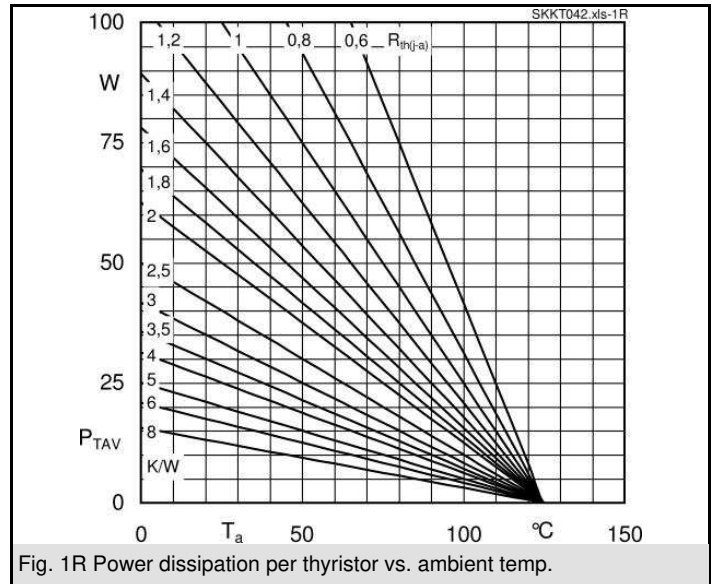
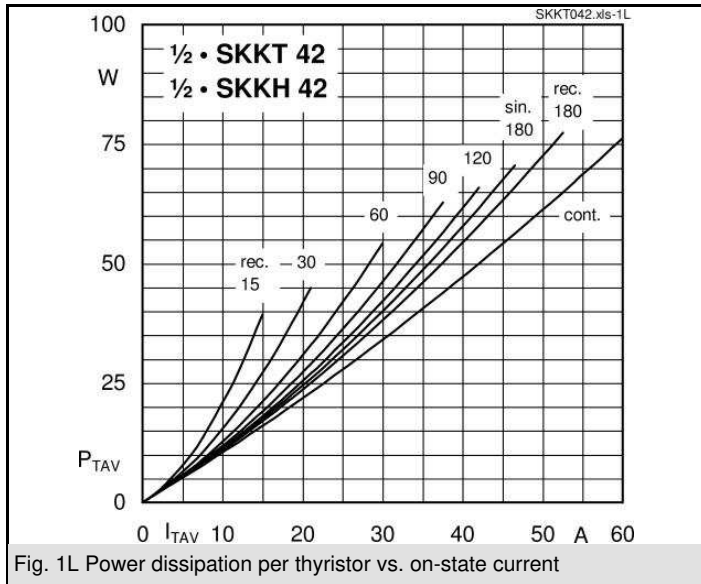

SKKT 42, SKKT 42B, SKKH 42

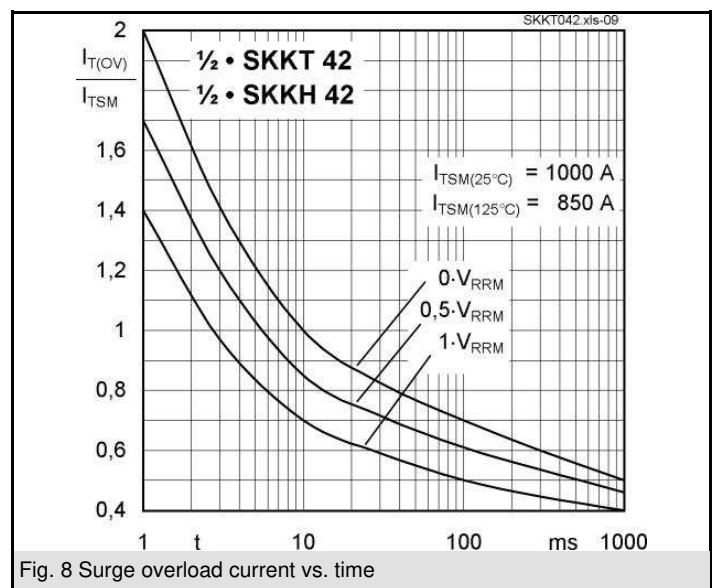
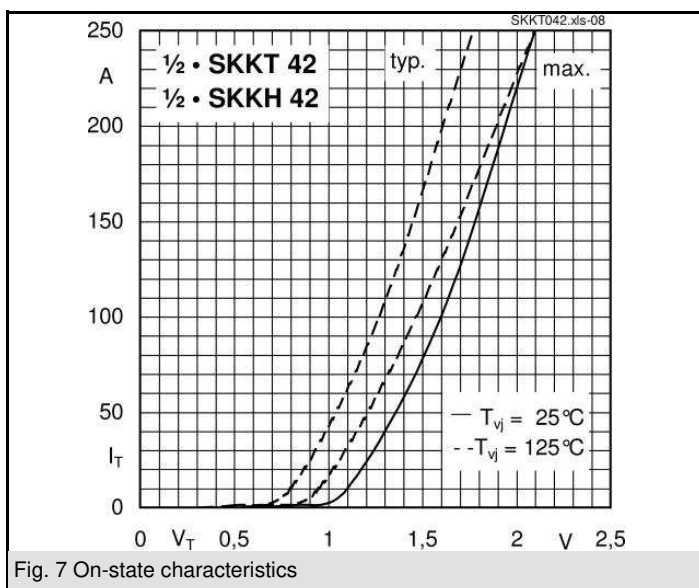
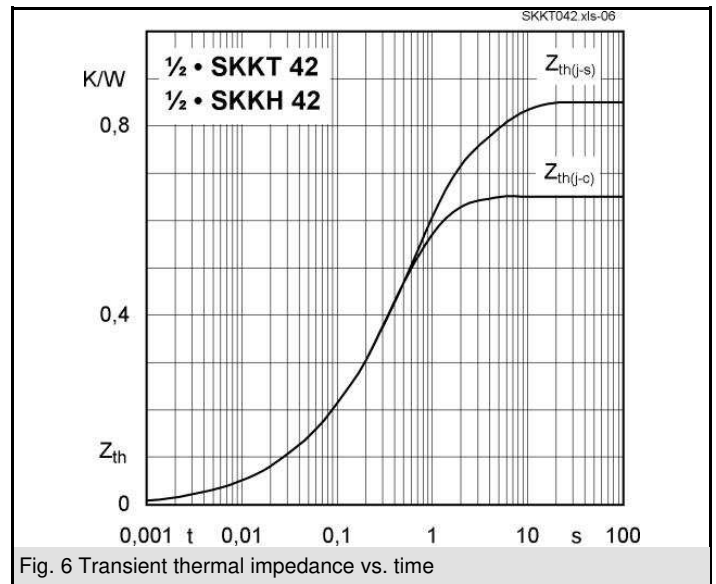
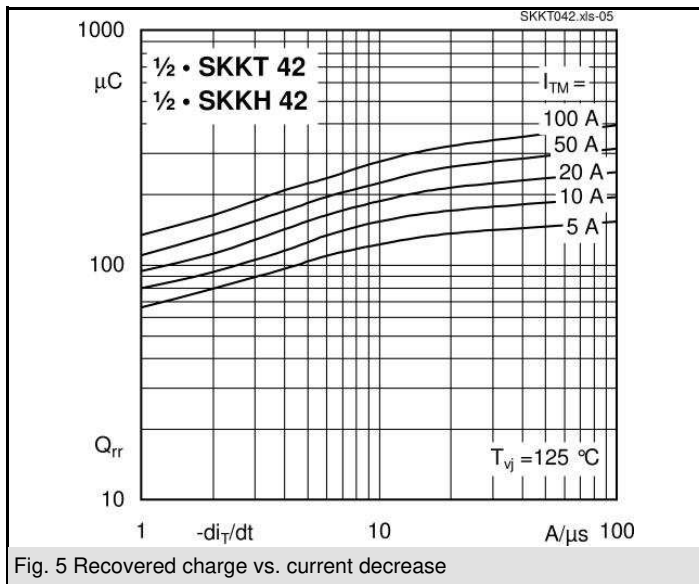
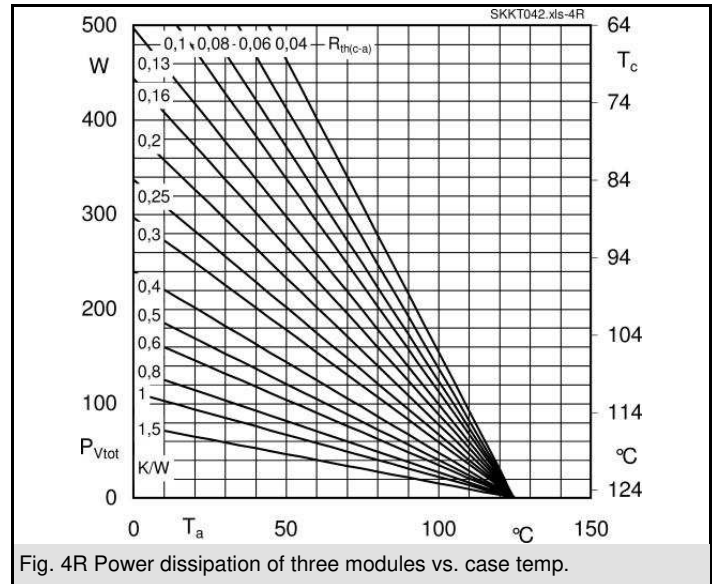
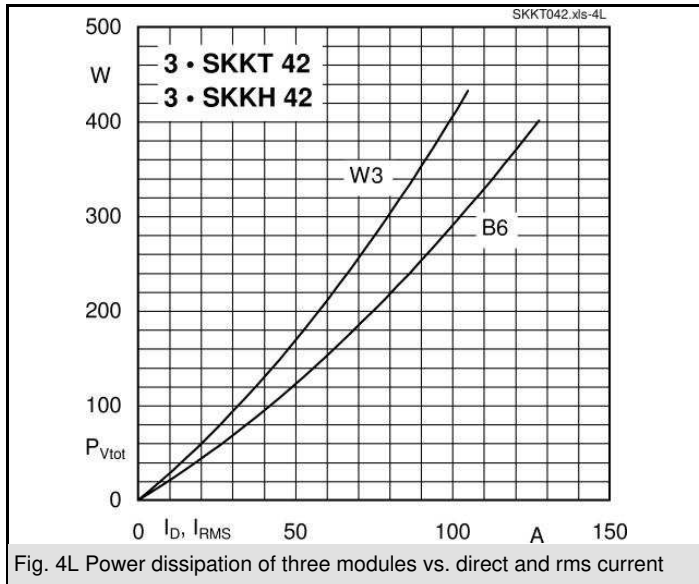

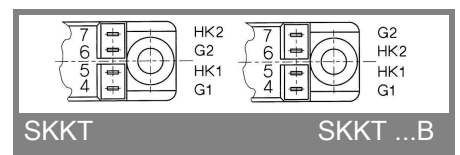
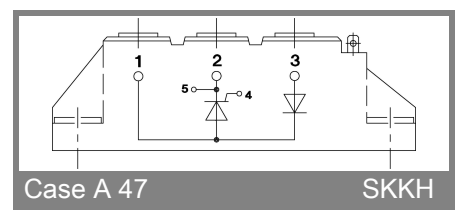
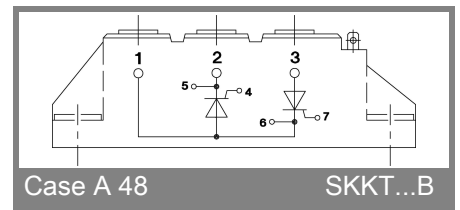
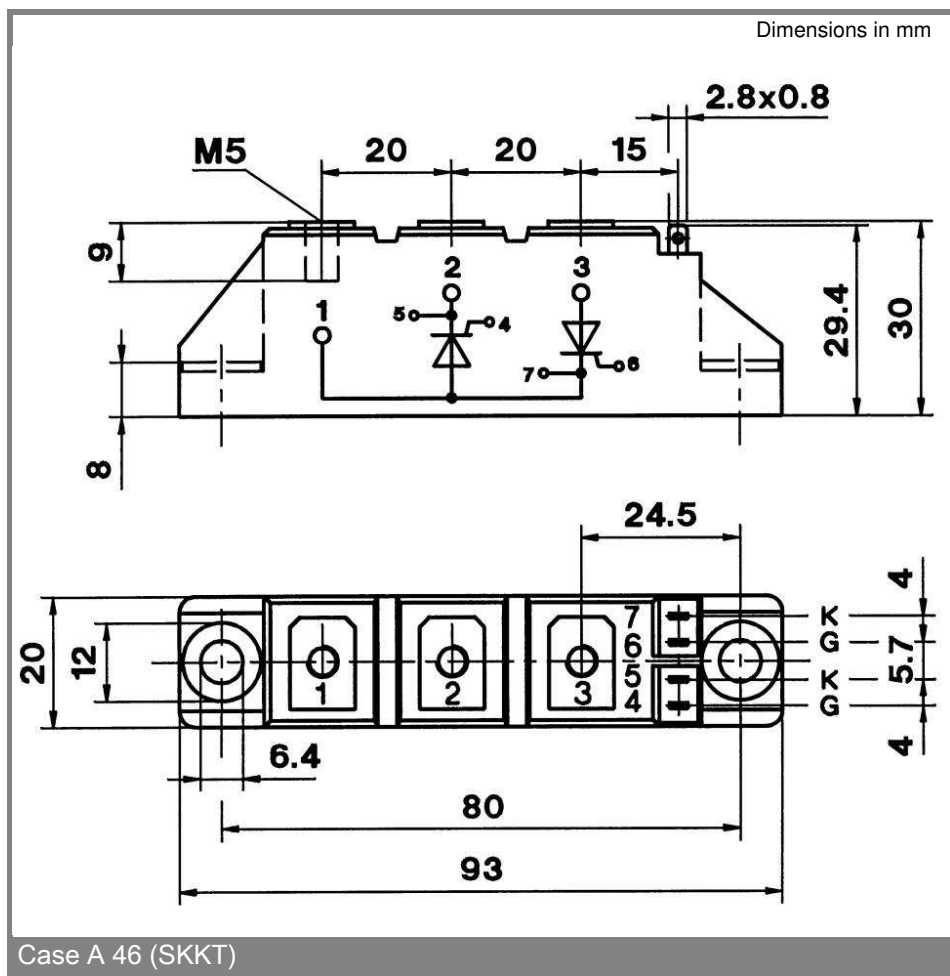
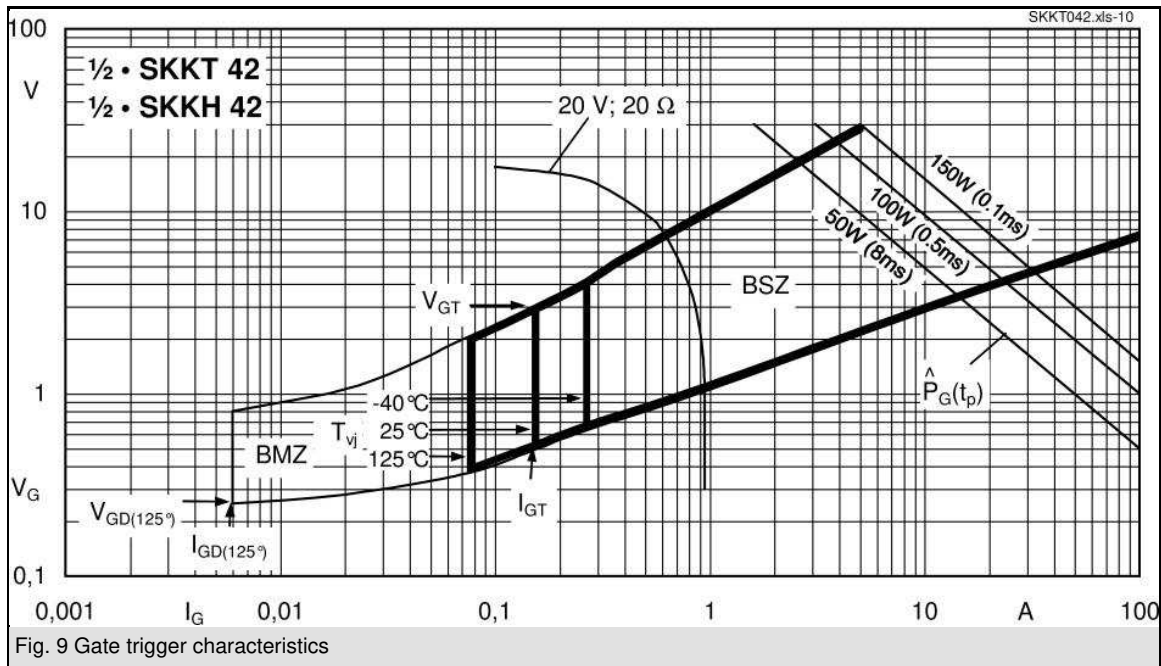

* The specifications of our components may not be considered as an assurance of component characteristics. Components have to be tested for the respective application. Adjustments may be necessary. The use of SEMIKRON products in life support appliances and systems is subject to prior specification and written approval by SEMIKRON. We therefore strongly recommend prior consultation of our personal.